

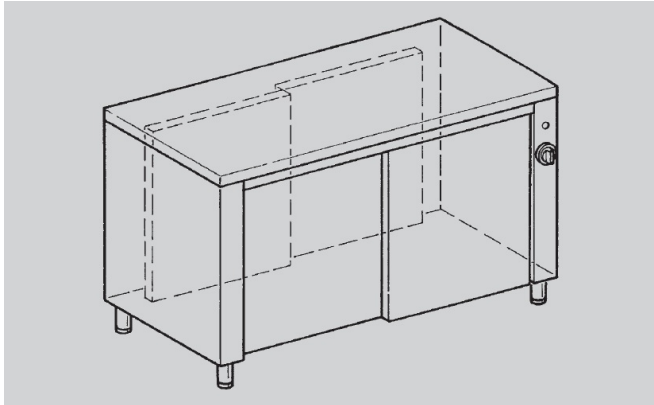

PREPARATION - EUCLIDE

TEP127



Armoires chaudes ventilées traversant

SPÉCIFICATIONS TECHNIQUES:

Dimensions exterieure - LxPxH (cm) 120x70x85

SPÉCIFICATIONS SUPPLÉMENTAIRES:

Poids (kg) 125

Volume (m3) 1,05