

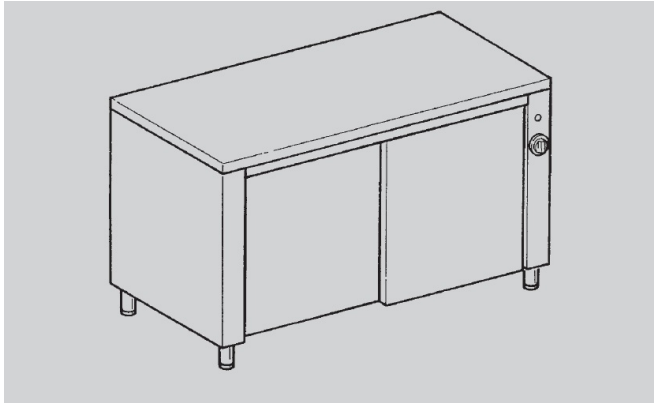

PREPARATION - EUCLIDE

**TE166**



Armoires chaudes ventilées

**SPÉCIFICATIONS TECHNIQUES:**

Dimensions exterieure - LxPxH (cm) 160x60x85

**SPÉCIFICATIONS SUPPLÉMENTAIRES:**

Poids (kg) 142

Volume (m3) 1,11