

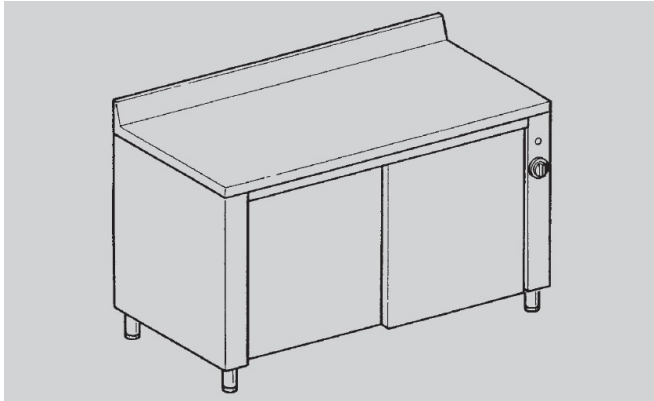

PREPARATION - EUCLIDE

TE146A



Armoires chaudes ventilées

SPÉCIFICATIONS TECHNIQUES:

Dimensions exterieure - LxPxH (cm) 140x60x85

SPÉCIFICATIONS SUPPLÉMENTAIRES:

Poids (kg) 131

Volume (m3) 1,09