

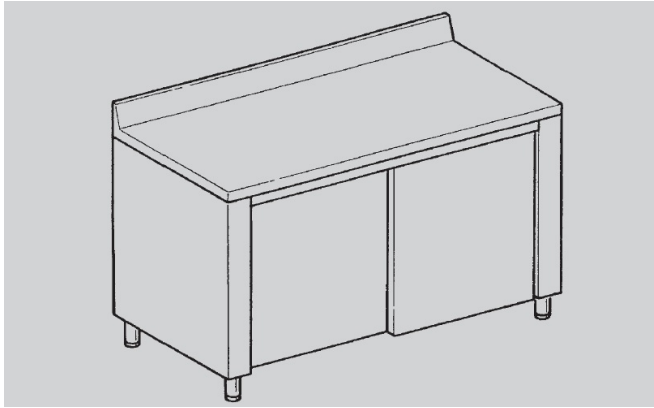

PREPARATION - EUCLIDE

TA106A



Tables de travail - 2 portes coulissante

SPÉCIFICATIONS TECHNIQUES:

Dimensions exterieure - LxPxH (cm) 100x60x85

SPÉCIFICATIONS SUPPLÉMENTAIRES:

Poids (kg) 50

Volume (m3) 0,35