

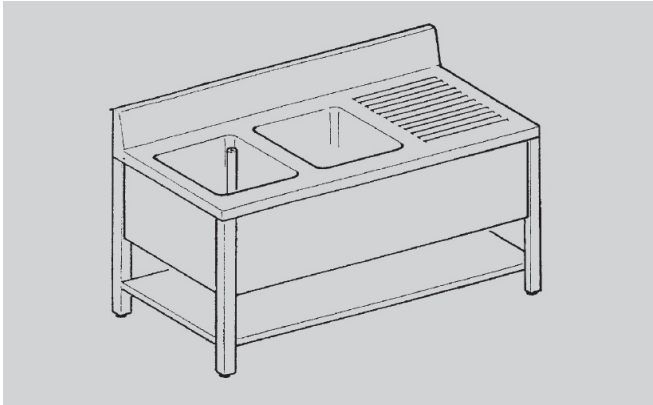

PREPARATION - EUCLIDE

LGR146D



prof. 60 cm - 2 cuve

SPÉCIFICATIONS TECHNIQUES:

Dimensions exterieure - LxPxH (cm)	140x60x85
------------------------------------	-----------

SPÉCIFICATIONS SUPPLÉMENTAIRES:

Poids (kg)	72
Volume (m3)	0,6