

**IT**

Struttura a monoscocca in acciaio inox AISI 304; finitura esterna satinata scotch-brite; spessore di isolamento 85mm per la scocca e 65mm per la porta, con schiuma poliuretanica ad alta densità (40 kg/m<sup>3</sup>) senza HFC; piedini in acciaio inox regolabili h120/150mm; cella con angoli interni arro- tondati per una perfetta pulizia ed igienicità; sbrinamento ed evaporazione dell'acqua di condensa a gas caldo; ventilatori elettronici a basso consumo energetico su 700lt TN/BT e 1400lt TN; griglie GN 2/1 in rislán; cremagliere porta griglie in acciaio inox estraibili senza utilizzo di utensili; flusso d'aria laterale; filtro condensatore amovibile di serie; porte auto chiudenti con fermo a 100°; unità refrigerante a monoblocco brevettata e tropicalizzata (in classe climatica 5); serratura di serie; luce di serie; comando LCD a cristalli liquidi ad alta visibilità; maniglia ergonomica a tutta altezza e doppia impugnatura; alimentazione a 230V/50Hz monofase standard.

**EN**

Stainless steel AISI 304 monocoque structure; scotch-brite external satin finish; 85 mm high density HFC free polyurethane foam insulation (40kg/m<sup>3</sup>) for the body and 65mm thickness for the door; stainless steel adjustable feet h120/150; cell with rounded internal edges for a perfect cleaning and hygiene; hot gas defrosting and condensation water evaporation; low energy consumption electronic fans on 700lt TN / BT and 1400lt TN; GN 2/1 Rislán grids; removable stainless steel racks for grids, no tools needed; lateral air flow; removable condenser filter as standard; self-closing doors from 100°; patented and tropicalized monobloc refrigerating unit (climatic class 5); lock as standard; lights as standard; high visibility LCD liquid crystal control; full-height comfort double grip; standard power supply 230 V / 50Hz monophase.

**FR**

Structure à caisse unique en acier inox AISI 304 ; finition extérieure satinée Scotch-brite ; épaisseur d'isolation par injection de mousse polyuréthane à haute densité (40 kg/m<sup>3</sup>) sans HFC de 85 mm pour la caisse et de 65 mm pour la porte ; pieds réglables en acier inox h120/150mm ; chambre froide avec angles internes arrondis pour un nettoyage et une hygiène parfaits ; dégivrage et évaporation de l'eau de condensation par gaz chaud ; ventilateurs électroniques à faible consommation d'énergie sur 700lt TN / BT et 1400lt TN ; grille GN2/1 en Rislán ; crémaillère inox amovible sans outils ; flux d'air latéral ; filtre condensateur amovible en standard ; porte à fermeture automatique à partir de 100° ; unité frigorifique avec monobloc breveté et tropicalisé (classe climatique 5) ; serrure de série ; éclairage de série ; contrôle LCD à cristaux liquides de haute visibilité ; poignée ergonomique à pleine hauteur et double manche ; alimentation standard 230 V / 50 Hz une seule phase.

**DE**

Monocoque-Ausführung aus Edelstahl AISI 304 mit satinierten Außenflächen (Scotch-Brite); 85 mm starke Rahmen-Isolierung und 65 mm starke Tür-Isolierung aus hochverdichtetem Polyurethanschaum (40kg/m<sup>3</sup>) ohne HFC; Stellfüße aus Edelstahl H 120/150; Kühlzelle mit abgerundeten Innenecken für eine einfache Reinigung und optimale Hygiene; automatische Kondenswasserverdunstung und Abtauung durch heißen Gas; niedriger Energieverbrauch elektrischer Lüfter auf 700 Lt TN / BT und 1400lt TN; GN 2/1 Rislán Gitter; Edelstahlstangen für Gitter, abnehmbar ohne den Einsatz von Werkzeugen; Abnehmbarer Kondensatorfilter als Standardausstattung; selbstschließende Tür ab 100°; patentiertes und tropikalisiertes Monoblockkälteaggregat (Klimatische Klasse 5); serienmäßiges Schloss; Serienbeleuchtung; LCD Bedienfeld mit hochsichtbare Flüssigkristalle; ergonomischer Doppel-Handgriff in voller Höhe; Standard Spannung 230 V / 50 Hz einphasig.

**ES**





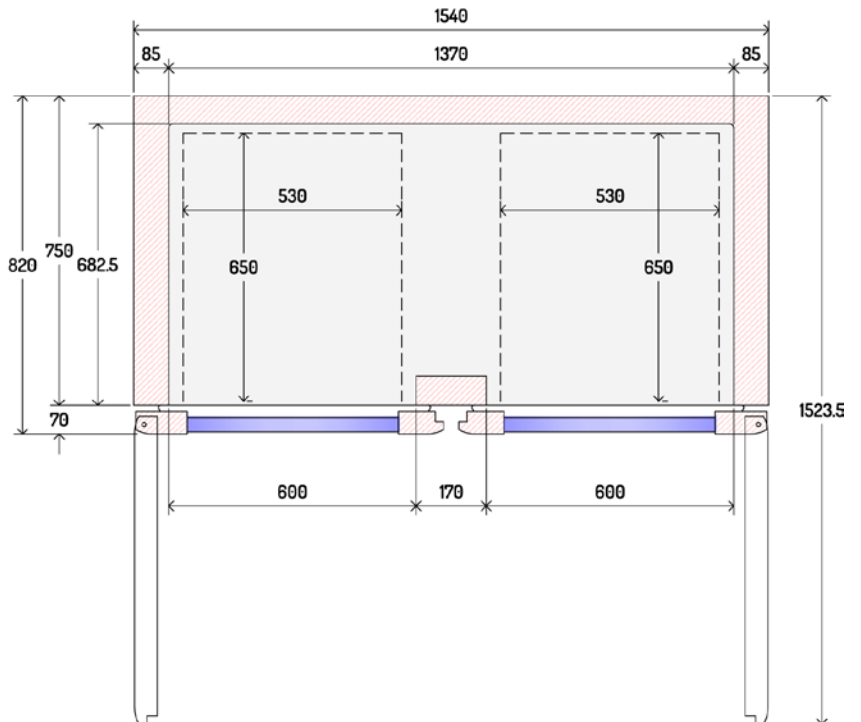
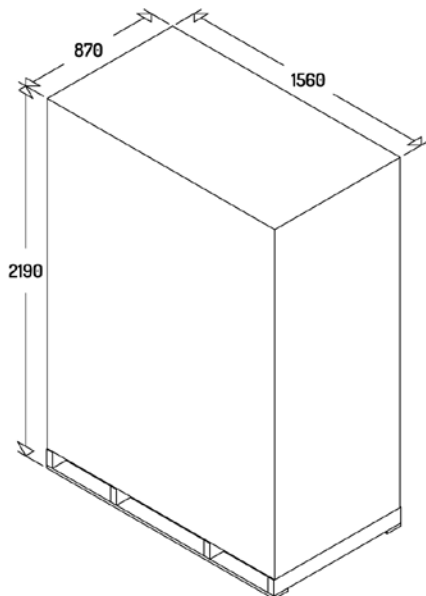
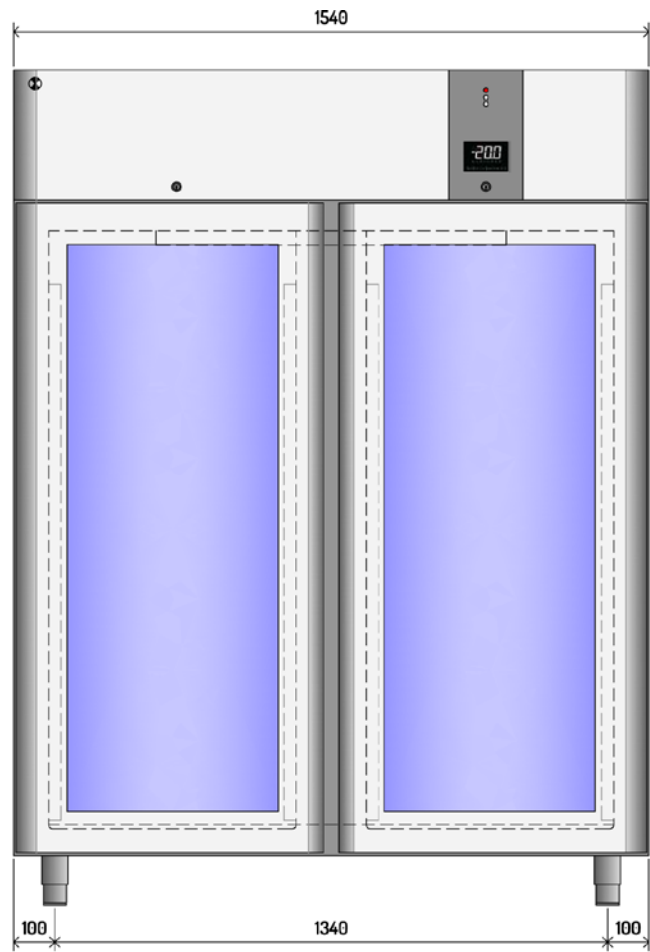
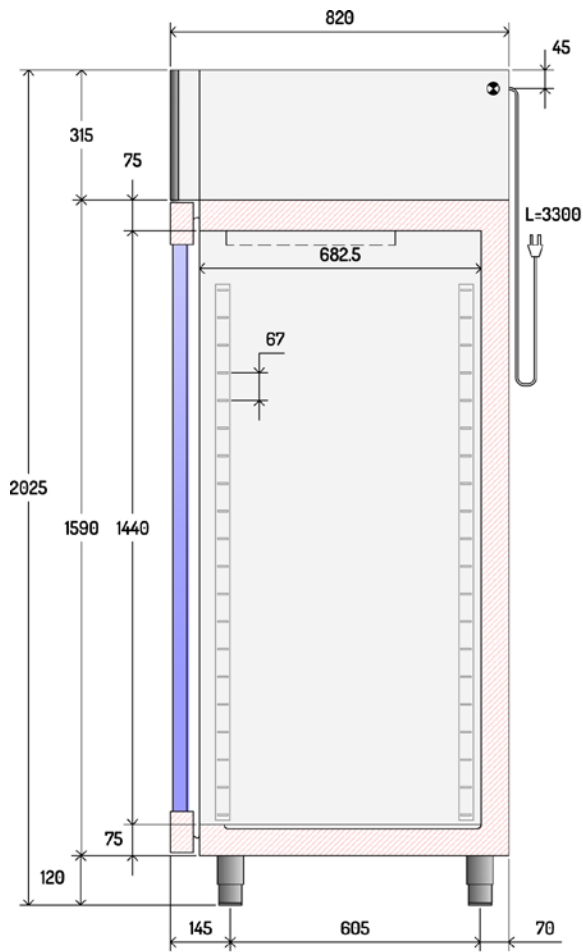

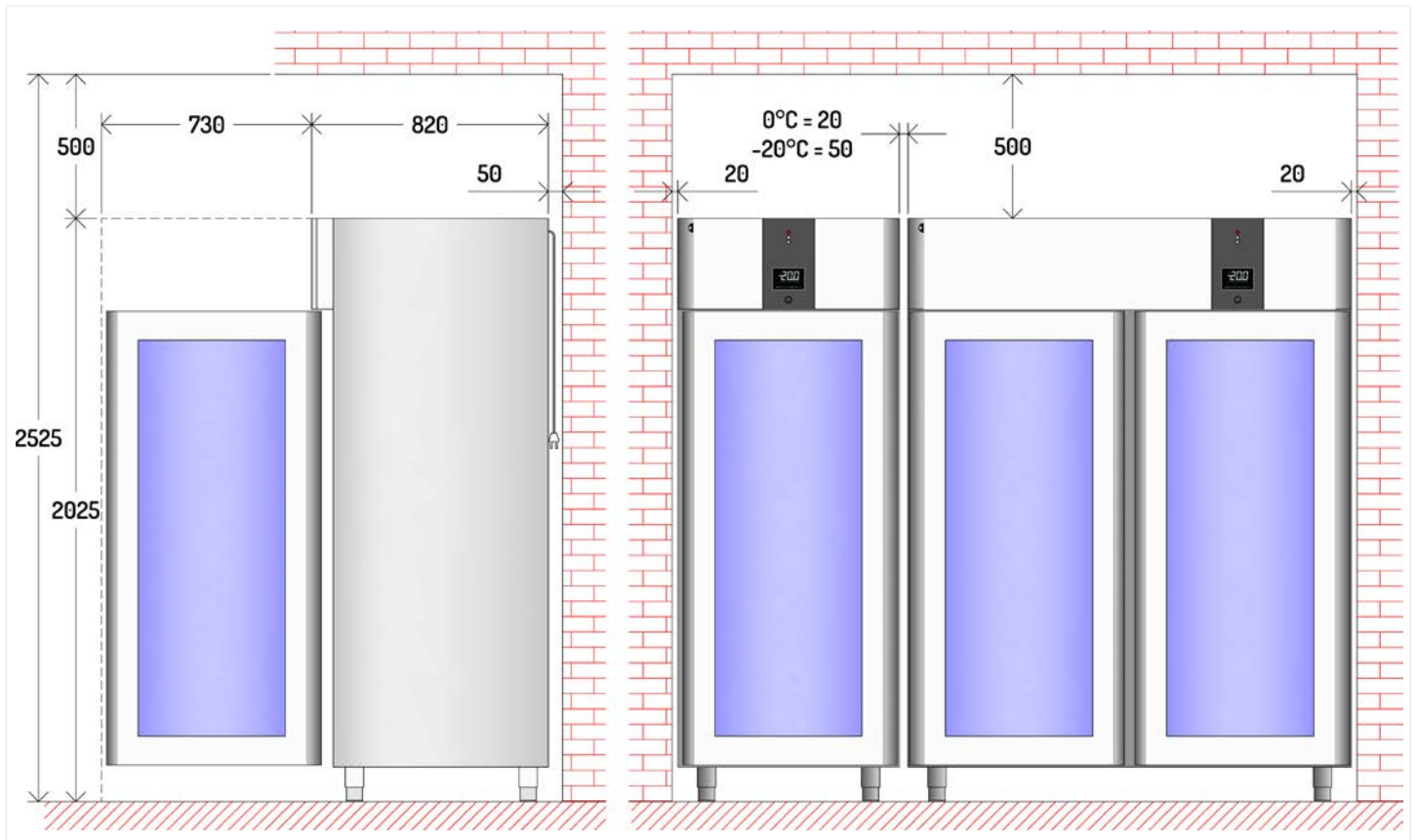









Estructura monocasco de acero inoxidable AISI 304; acabado exterior satinado scotch-brite; espesor de aislamiento 85 mm para el casco y 65 mm para la puerta con espuma de poliuretano de alta densidad (40 kg/m<sup>3</sup>) sin HFC; piés ajustable de acero inoxidable h120/150mm; cámara con equinas interiores redondeadas para un perfecta limpieza y higiene; ventiladores electrónicos de bajo consumo de energía en 700lt TN / BT y 1400lt TN; rejillas rislán GN 2/1; cremallera para rejillas de acero inoxidable extraíbles, sin el uso de herramientas; flujo de aria lateral; filtro de condensador extraíble como estándar; puertas con autocerrado con bloqueo a 100°; unidad refrigeradora monocasco patentada y tropicalizada (en clase climática 5); cerradura de serie; luz de serie; comando LCD de cristal líquido de alta visibilidad; manija ergonómica por toda la altura y con doble empuñadura ; alimentación de 230V/50Hz monofásica estándar.







	<b>Ricambio Minimo Aria</b> Minimum Replacement Air	mc/h	320
	<b>Calore Emesso</b> Heat Output	watt	560
	<b>Versione Remota</b> Remote Version		
	<b>Linea di Aspirazione</b> Suction Line	mm	ø 8
	<b>Linea Liquido</b> Liquid Line	mm	ø 6
	<b>Potenza Sbrinamento Elettrico</b> Electric Defrost Power	watt	450

Modello - Model - Model - Gerätetyp		AE14V2501
G N		
		
<input type="checkbox"/> <b>Descrizione</b> - Description - Description - Beschreibung		<b>1400</b>
 <b>Range</b>		0°C +10°C
<input type="checkbox"/> <b>Funzionamento</b> - Operating Mode - Mode de fonctionnement - Betriebsmodus S = Statico - Static - Statique - Stille Kühlung V = Ventilato - Ventilated - Ventilé - Umluftkühlung		<b>V</b>
<input type="checkbox"/> <b>Capacità lorda</b> - Gross Capacity - Capacité brute - Bruttovolumen	l	1340
<input checked="" type="checkbox"/> <b>Materiale Esterno</b> - External Material - Matériau Extérieur - Verstoff Außen		<b>304</b>
 <b>Dimensioni esterne</b> - External Dimension - Dimensions externes - ußenabmessungen		
Lunghezza - Width - Largeur - Breite	mm	1540
Profondità / con porte aperte - Depth / with open doors Profondeur avec portes ouverte - Tiefe/mit geöffneter Tür	mm	820/1520
Altezza - Height - Hauteur - Höhe	mm	2025
<input checked="" type="checkbox"/> <b>Materiale Interno</b> - Internal Material - Matériau Intérieur - Verstoff Innen		<b>304</b>
 <b>Dimensioni interne</b> - Internal Dimension - Dimensions internes - Innenabmessungen		
Lunghezza - Width - Largeur - Breite	mm	1370
Profondità - Depth - Profondeur - Tiefe	mm	682,5
Altezza - Height - Hauteur - Höhe	mm	1440
 <b>Porte</b> - Doors - Portes - Türen		1, Glass
<b>Dotazione Standard</b> - Standard Equipment - Equipement standard - Standardausstattung		Griglia plastificata - Plastic-Coated Grid -Grille Plastifée Kunststoff-Beschichtetes Gitter  3 + 3 (530x650)
<input type="checkbox"/> <b>Luce interna</b> - Internal light - Eclairage intérieure - Innerbeleuchtung		●
 <b>Serratura</b> - Lock - Serrure - Schloss		●
 <b>Sbrinamento</b> - Defrost - Dégivrage - Abtauen		
Type		Hot Gas
N° Defrost in 24 hrs.		INTELLI
Evaporazione acqua sbrinamento - Evaporation of defrost water Evaporation eau de dégivrage - Tauwasserverdunstung		Automatic by Hot Gas
 <b>Compressor</b>		
Model		NEU6210U
Potenza - Power - Puissance - Leistung	HP	1/3
T° Evaporation	°C	-10
Potenza frigorifera - Refrigerant Power - Puissance frigorifique - Kälteleistung	watt	740
 <b>Refrigerante</b> - Refrigerant type - Réfrigérant type - Kältemitteltyp	GWP	R290 / 3
<b>Quantità di refrigerante</b> - Refrigerant quantity - Quantité de réfrigérant - Kältemittelmenge	gr	120
 <b>Potenza assorbita</b> - Total Power - Puissance - Leistung	watt	500W - 2,6A 700W - 4,9A
<b>Tensione alimentazione</b> - Supply Voltage - Tension d'alimentation - Anschlussspannung	V	230V~ 50Hz
 <b>Noise Level</b>	dbA	49
<input type="checkbox"/> <b>Peso Netto</b> - Net weight - Poids net - Netto Gewicht	kg	280
 <b>Versione Predisposta</b> - Remote version - Version sans groupe - Modelle ohne Aggregat Sbrinamento elettrico - Electrical defrosting - Dégivrage électrique - Elektrische Abtauung		- - -
 <b>Efficienza Energetica</b> - Energy Efficiency - Classe Énergie - Energieeffizienzklasse		D
 <b>Energia</b> - Energy - Énergie - Energie	kWh / annum	1675
<input checked="" type="checkbox"/> <b>Volume Netto</b> - Net Volume - Volume Net - Nettoinhalt	l	1096
 <b>Classe Climatica</b> - Climate Class - Classe Climatique - Klima Klasse		<b>4</b> 30°C-55%

● = Dotazione di serie - Standard equipment - Dotation standard - Serien Ausstattung □ = Optional

Il costruttore si riserva il diritto di apportare modifiche ai prodotti senza preavviso.  
The manufacturer reserves the rights to modify its products without prior notice.  
Le constructeur se réserve le droit d'apporter des modifications aux produits sans préavis.  
Veränderungen an den Produkten können vom Hersteller ohne Vorankündigung vorgenommen

ILSA  
S.p.A

Via Ferrovia, 31  
I - 31010 Castello Roganzuolo  
di San Fior (Tv)  
ITALY

Tel. +39 0438 4905  
Fax +39 0438 400791

