





G140S



Design S

Fuel Type	Gas
Oven Type	Static

Gas ovens with Design S are basic one with metal cover and an arc facade finish – simple, elegant very durable where quality is viable. Those ovens are suitable both for inside kitchen use and building in option where only the oven face will be visible for customers. Currently no colour options are available.

Capacity	10  30 cm		Thermal Power	30 kW	
Productivity	150  per hour		Gas Connection	3/4"	
Gas Consumption 	Natural Gas	LPG	Gas Pressure	G30-31	G20
	4.2 mc/h	3.2 kg/h		37 mbar	20 mbar
Weight 	1800 kg		Electrical Supply 	230V/50Hz	

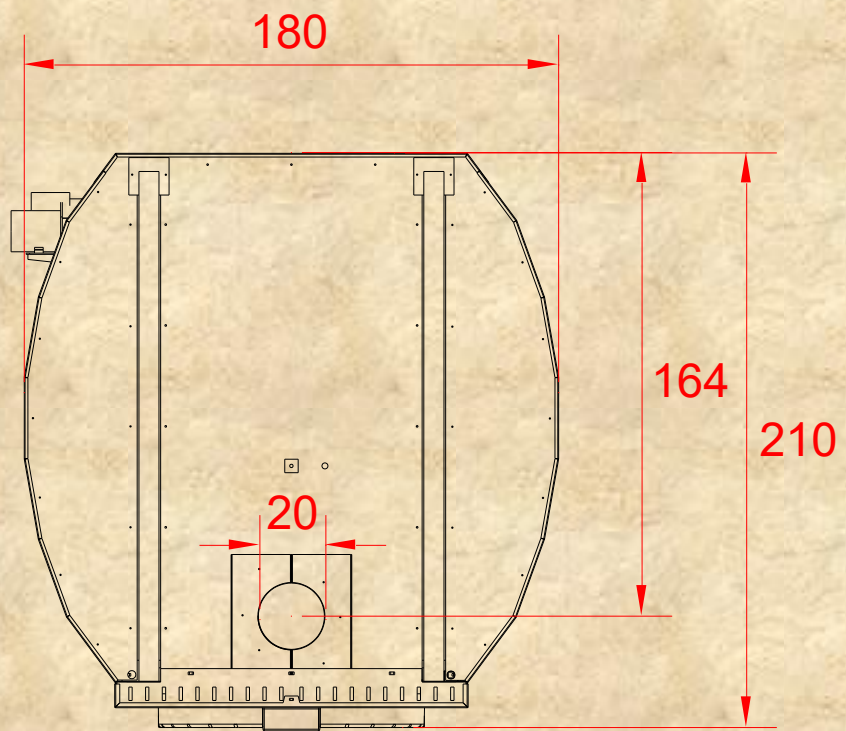
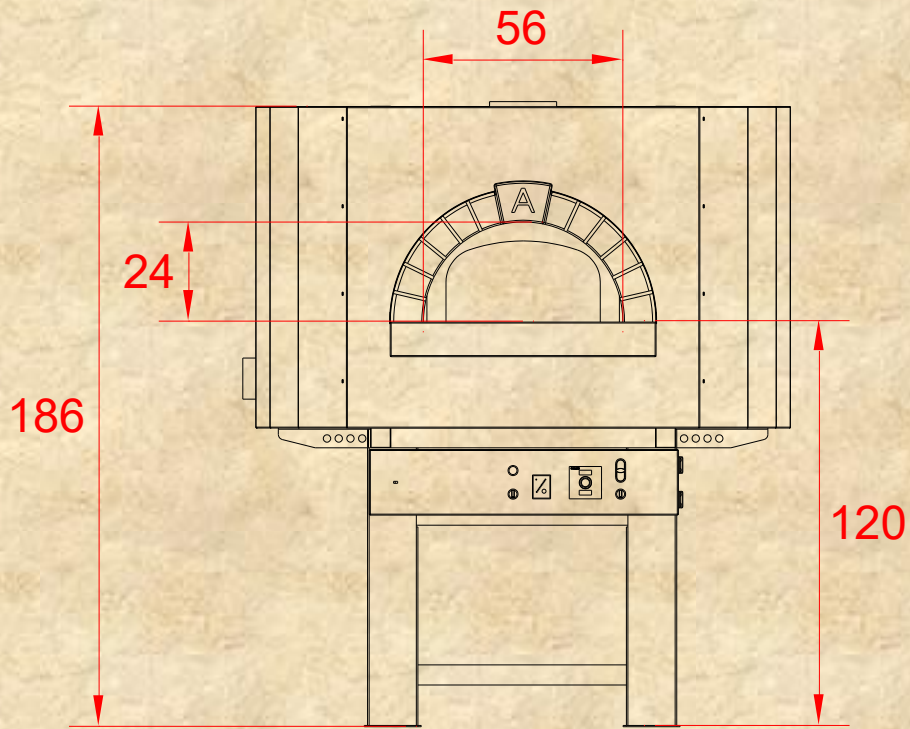

***Dimensions in cm**