

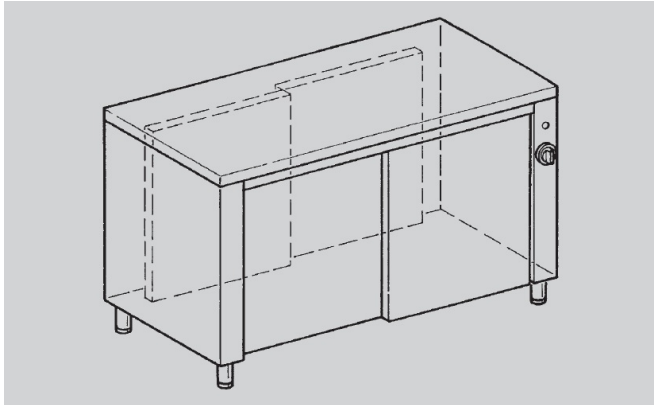

PREPARATION - EUCLIDE

TEP207



Armoires chaudes ventilées traversant

SPÉCIFICATIONS TECHNIQUES:

Dimensions exterieure - LxPxH (cm) 200x70x85

SPÉCIFICATIONS SUPPLÉMENTAIRES:

Poids (kg) 172

Volume (m3) 1,27