

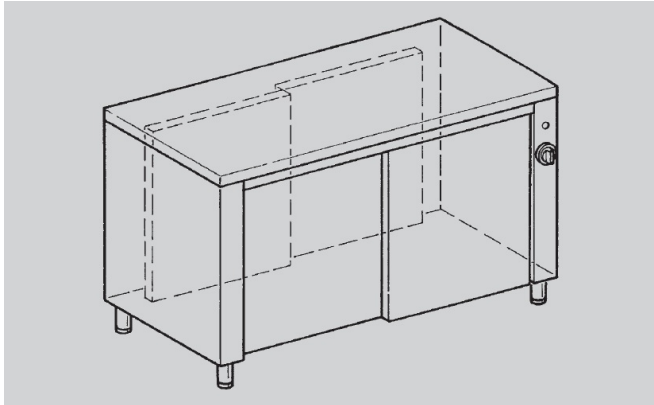

PREPARATION - EUCLIDE

**TEP147**



Armoires chaudes ventilées traversant

**SPÉCIFICATIONS TECHNIQUES:**

Dimensions exterieure - LxPxH (cm) 140x70x85

**SPÉCIFICATIONS SUPPLÉMENTAIRES:**

Poids (kg) 139

Volume (m3) 1,1