

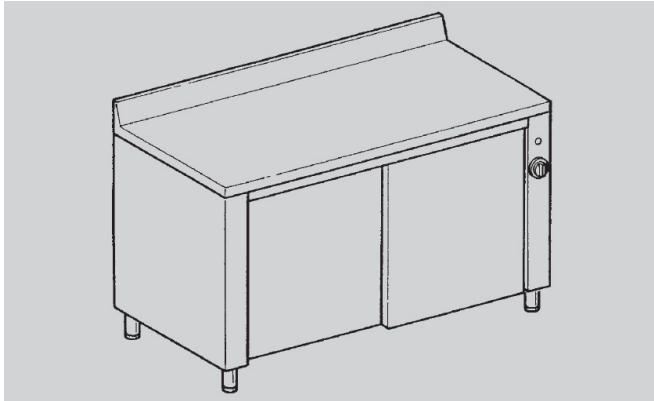

PREPARATION - EUCLIDE

TE126A



Armoires chaudes ventilées

SPÉCIFICATIONS TECHNIQUES:

Dimensions exterieure - LxPxH (cm) 120x60x85

SPÉCIFICATIONS SUPPLÉMENTAIRES:

Poids (kg) 121

Volume (m3) 1,05