

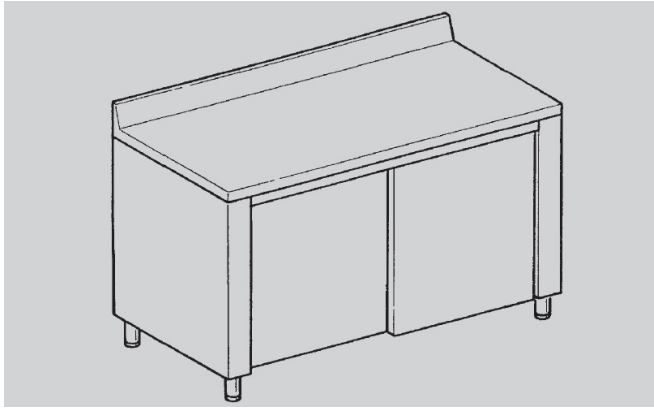

PREPARATION - EUCLIDE

TA126A



Tables de travail - 2 portes coulissante

SPÉCIFICATIONS TECHNIQUES:

Dimensions exterieure - LxPxH (cm) 120x60x85

SPÉCIFICATIONS SUPPLÉMENTAIRES:

Poids (kg) 105

Volume (m3) 0,85