

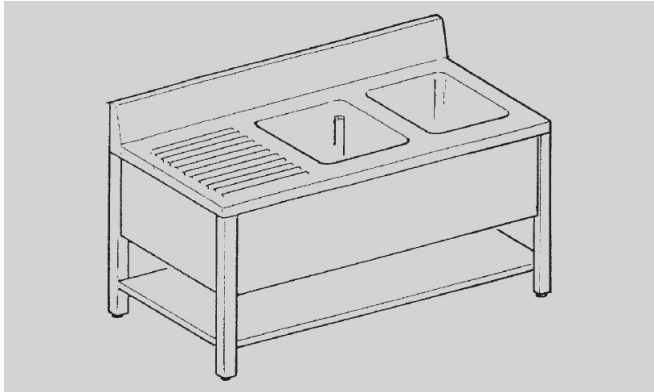

PREPARATION - EUCLIDE

LGR187S



prof. 70 cm - 2 cuve

SPÉCIFICATIONS TECHNIQUES:

Dimensions exterieure - LxPxH (cm)	180x70x85
------------------------------------	-----------

SPÉCIFICATIONS SUPPLÉMENTAIRES:

Poids (kg)	80
Volume (m3)	0,7